



KLAUS Multiparking GmbH
Hermann-Krum-Straße 2
D-88319 Aitrach
Fon +49 (0) 75 65 508-0
Fax +49 (0) 75 65 508-88
info@multiparking.com
www.multiparking.com

PRODUCT DATA



multibase U10 EB

2000 kg [4400 lbs] ¹
2600 kg [5730 lbs] ²

Dimensions

All space requirements are minimum finished dimensions.

Tolerances for space requirements $+3 \left[+1 \right]$ ³

EB (single platform) = 1 + 1 vehicles

Dimensions: cm [ft] (1 cm = 0,393 in)
Weights: kg [lbs] (1 kg = 2.2 lbs)
Forces: kN [lbf] (1 kN = 224.8 lbf)
Temperature: °C [°F] (0° C = 32° F)

Suitable for

Standard passenger cars:
Limousine, Station Wagon, SUV, Van
according to clearance and maximum
surface load.

	Standard	Special ²
Width	190 cm [6'-3"] ⁴	190 cm [6'-3"] ⁴
Weight	see page 4	
Wheel load	see page 4	

Clearance profile

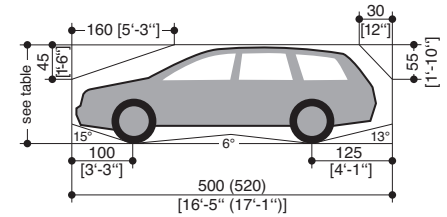

Environmental conditions ¹³

Wind zone 3 from 0.47 kN/m²
[9.8 lbf/ft²] in accordance with
DIN EN 1991-1-4.

Snow load zone 3 from 6.86 kN/m²
[143 lbf/ft²] in accordance with
DIN EN 1991-1-3.

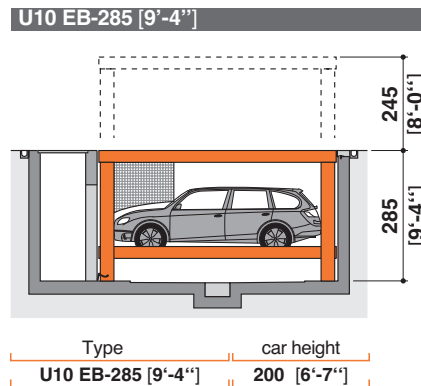
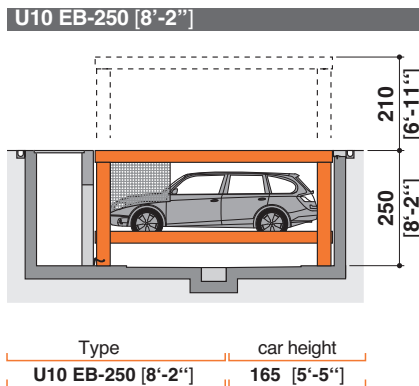
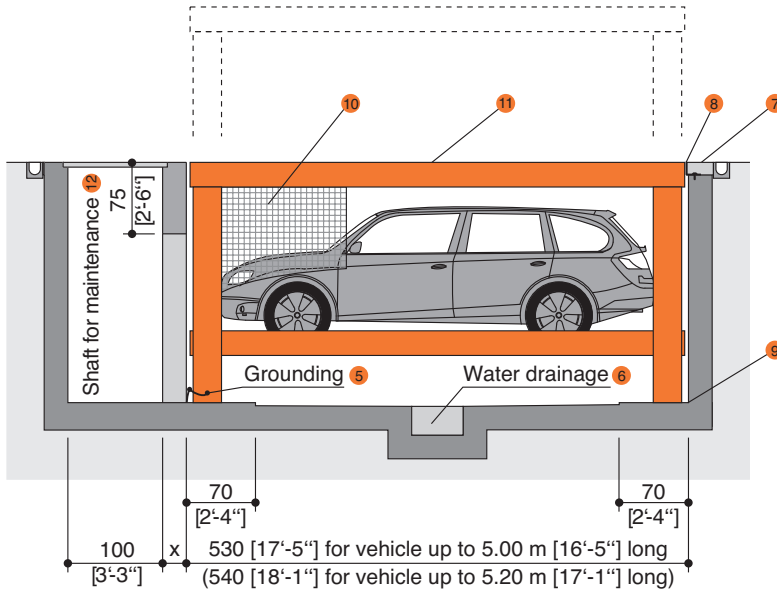

- ¹ Standard type
 - ² Special system: maximum load for extra charge.
 - ³ To follow the minimum finished dimensions, make sure to consider the tolerances according to VOB, part C (DIN 18330 and 18331) and the DIN 18202.
 - ⁴ Car width for platform width 230 cm [7'-7"]. If wider platforms are used it is also possible to park wider cars.
 - ⁵ Potential equalization from foundation grounding connection to system (provided by the customer).
 - ⁶ Slope with drainage channel and sump see page 6.
 - ⁷ In compliance with DIN EN 14010, 10 cm [4"] wide yellow-black markings compliant to ISO 3864 must be applied by the customer to the edge of the pit in the entry area to mark the danger zone (see „load plan“ page 5).
 - ⁸ Pit edge see page 6.
 - ⁹ At the transition section between pit floor and walls no hollow mouldings/coves are possible. If hollow mouldings/coves are required, the systems must be designed smaller or the pits accordingly wider.
 - ¹⁰ Security fences are mounted in the side and rear area, under certain structural conditions these can be dispensed with. This requires consultation with KLAUS Multiparking.
 - ¹¹ The upper platform is a frame construction. Flooring can be provided by the customer (e.g. soil/turf, sandbed/turfblock, sandbed/marble, etc.). Maximum weight of customer coating 250 kg/m² [5933 lbs/ft²].
The upper platform is at ground level and is traversible when in lowered position (vehicle load: 2600 kg [5730 lbs] maximum, wheel load: 650 kg [1430 lbs] maximum). On special conditions the upper platform may be used as parking space.
 - ¹² A separate shaft for maintenance is required on site (with shaft covering, shaft ladder and passage to the pit). Access to the shaft for maintenance must be secured on site – this requires consultation with KLAUS Multiparking. The hydraulic unit is also housed in the shaft for maintenance.
 - ¹³ Snow load data for system in lowered position see page 4.
- !** After operation, the system must always be run into the lowest final position (key interlock).

Page 1
Section
Dimensions
Car data

Page 2
Width dimensions

Page 3
Width dimensions

Page 4
Function
Approach
Load per parking sp.

Page 5
Load plan

Page 6
Pit edge

Page 7
Electrical installation
Technical data

Page 8
Tec. data
To be performed by the customer

Page 9
Description

Width dimensions – Single platform (EB) and Serial system (with dividing walls)

Top view closed pit

Single platform (EB)

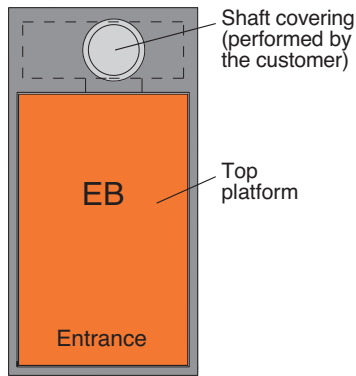

Serial system (with dividing walls)

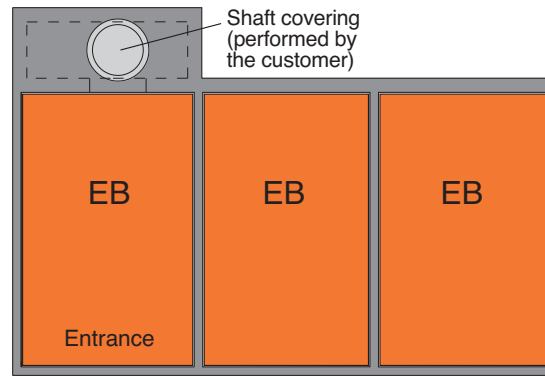

Pit dimensions

Front view

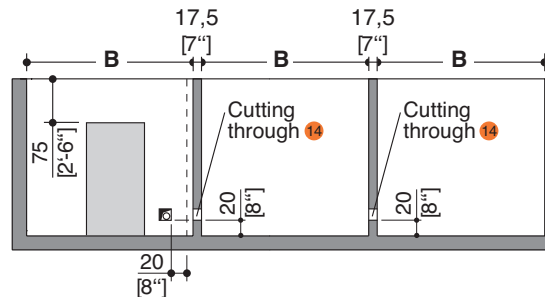
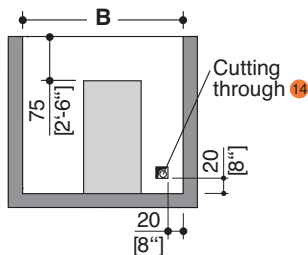

Top view

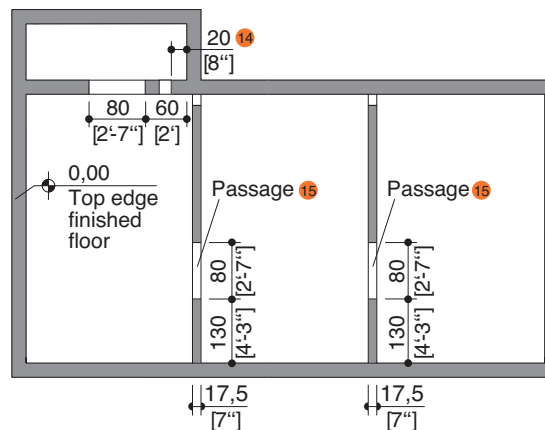
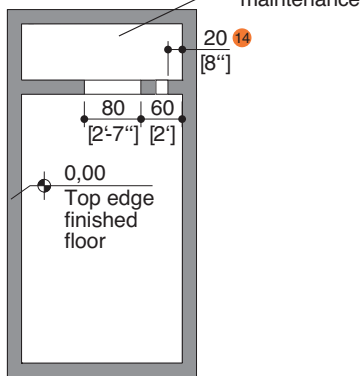

Pit dimension B	Usable platform width	Usable platform width
	parking levels	top platform
275 [9'-0"]	230 [7'-7"]	270 [8'-10"]
285 [9'-4"]	240 [7'-10"]	280 [9'-2"]
295 [9'-8"]	250 [8'-2"]	290 [9'-6"]
305 [10'-0"]	260 [8'-6"]	300 [9'-10"]
315 [10'-4"]	270 [8'-10"]	310 [10'-2"]

! All sidewalls must be in a rectangular angel. Max. tolerances are 1 cm [0.4"]!
 Warning: If the side or backside is freely accessible these areas must be safeguarded (safety fences, safety grids, marking etc.). Measures to be taken according to project.
 End parking spaces are generally more difficult to drive into. Therefore we recommended for end parking spaces our wider platforms. Parking on standard width platforms with larger vehicles may make getting into and out of the vehicle difficult. This depends on type of vehicle, approach and above all on the individual driver's skill.
 For vehicle widths larger 190 cm [6'-3"] a platform width of 270 cm [8'-10"] is required in order to enable the driver to get in and out of the car on one side.

- 14** For dividing walls: cutting through 15 x 15 cm [6" x 6"].
- 15** The passage to the neighbouring system must be the same height as the passage from the shaft for maintenance in the pit.

Page 1
Section
Dimensions
Car data

Page 2
Width
dimensions

Page 3
Width
dimensions

Page 4
Function
Approach
Load per
parking sp.

Page 5
Load plan

Page 6
Pit edge

Page 7
Electrical
installation
Technical
data

Page 8
Tec. data
To be performed by the customer

Page 9
Description

Width dimensions – 2 x Single platform (without dividing walls)

Top view closed pit

2 x Single platform (without dividing wall)

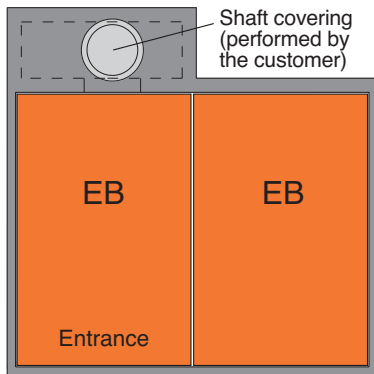

Pit dimensions

Front view

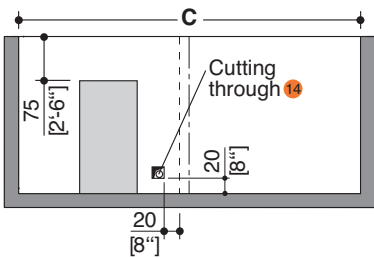

Top view

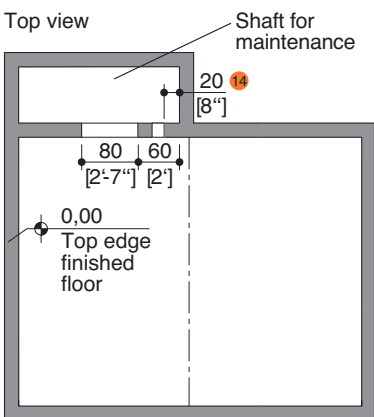

Pit dimension C	Usable platform width	Usable platform width
	parking levels	top platform
547,5 [18'-0"]	2 x 230 [2 x 7'-7"]	2 x 270 [2 x 8'-10"]
567,5 [18'-7"]	2 x 240 [2 x 7'-10"]	2 x 280 [2 x 9'-2"]
587,5 [19'-3"]	2 x 250 [2 x 8'-2"]	2 x 290 [2 x 9'-6"]
607,5 [19'-11"]	2 x 260 [2 x 8'-6"]	2 x 300 [2 x 9'-10"]
627,5 [20'-7"]	2 x 270 [2 x 8'-10"]	2 x 310 [2 x 10'-2"]



All sidewalls must be in a rectangular angel. Max. tolerances are 1 cm [0.4"]!

Warning: If the side or backside is freely accessible these areas must be safeguarded (safety fences, safety grids, marking etc.). Measures to be taken according to project.

End parking spaces are generally more difficult to drive into. Therefore we recommended for end parking spaces our wider platforms. Parking on standard width platforms with larger vehicles may make getting into and out of the vehicle difficult. This depends on type of vehicle, approach and above all on the individual driver's skill.

For vehicle widths larger 190 cm [6'-3"] a platform width of 270 cm [8'-10"] is required in order to enable the driver to get in and out of the car on one side.

¹⁴ For dividing walls: cutting through 15 x 15 cm [6" x 6"].

Page 1
Section
Dimensions
Car data

Page 2
Width
dimensions

Page 3
Width
dimensions

Page 4
Function
Approach
Load per
parking sp.

Page 5
Load plan

Page 6
Pit edge

Page 7
Electrical
installation
Technical
data

Page 8
Tec. data
To be performed
by the
customer

Page 9
Description

Function

System lifted

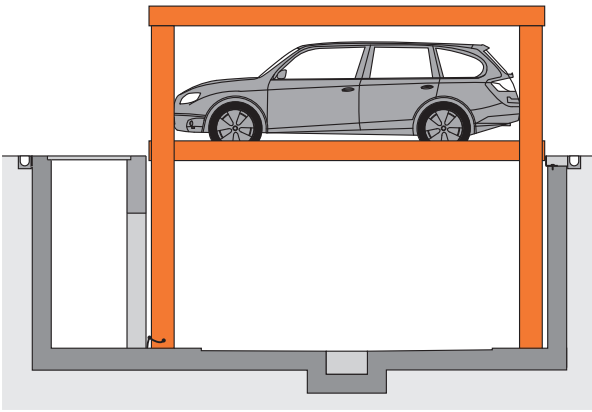

System lowered

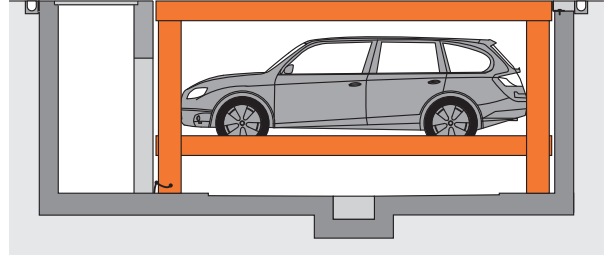

Approach

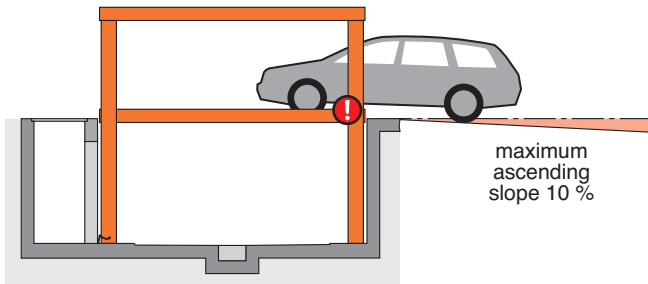
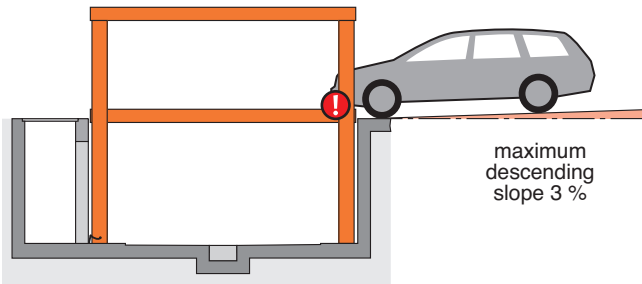

! The illustrated maximum approach angles must not be exceeded. Incorrect approach angles will cause serious manoeuvring & positioning problems on the parking system for which the local agency of KLAUS Multiparking accepts no responsibility.

Load per parking space

For countries where snow loads are a crucial factor (weights in kg)

MultiBase U10 2,6 / 2,0 to.

parking spaces	weight	wheel load
upper parking space	2000 kg	500 kg
lower parking space	2000 kg	500 kg

MultiBase U10 2,6 / 2,6 to. – for extra charge

parking spaces	weight	wheel load
upper parking space	2000 kg	500 kg
lower parking space	2600 kg	650 kg

For countries where snow loads are a crucial factor (weights in lbs)

MultiBase U10 5730 / 4400 lbs

parking spaces	weight	wheel load
upper parking space	4400 lbs	1100 lbs
lower parking space	4400 lbs	1100 lbs

MultiBase U10 5730 / 5730 lbs – for extra charge

parking spaces	weight	wheel load
upper parking space	4400 lbs	1100 lbs
lower parking space	5730 lbs	1430 lbs

For countries where snow loads is no relevant factor (weights in kg)

MultiBase U10 2,6 / 2,0 to.

parking spaces	weight	wheel load
upper parking space	2600 kg	650 kg
lower parking space	2000 kg	500 kg

MultiBase U10 2,6 / 2,6 to. – for extra charge

parking spaces	weight	wheel load
upper parking space	2600 kg	650 kg
lower parking space	2600 kg	650 kg

For countries where snow loads is no relevant factor (weights in lbs)

MultiBase U10 5730 / 4400 lbs

parking spaces	weight	wheel load
upper parking space	5730 lbs	1430 lbs
lower parking space	4400 lbs	1100 lbs

MultiBase U10 5730 / 5730 lbs – for extra charge

parking spaces	weight	wheel load
upper parking space	5730 lbs	1430 lbs
lower parking space	5730 lbs	1430 lbs

! Applies to a snow depth of 20 cm [8"]; in case of larger snow depths the snow must be removed.

Page 1
Section
Dimensions
Car data

Page 2
Width
dimensions

Page 3
Width
dimensions

Page 4
Function
Approach
Load per
parking sp.

Page 5
Load plan

Page 6
Pit edge

Page 7
Electrical
installation
Technical
data

Page 8
Tec. data
To be performed by the customer

Page 9
Description

Load plan

Section

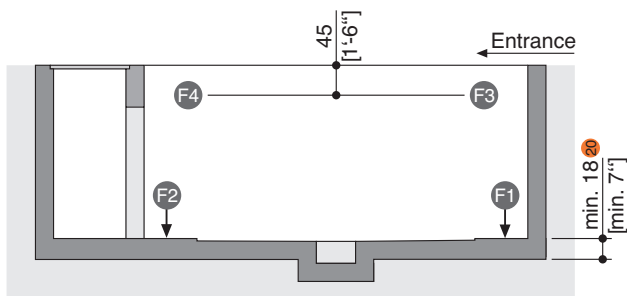

Top view

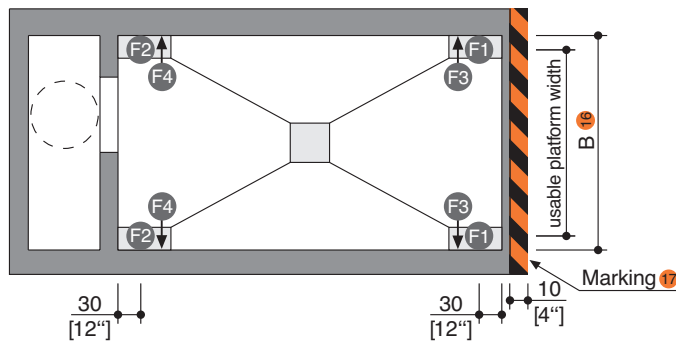

Platform load in kg

Upper platform with sheet metal plates ¹⁸

usable platform width	F1	F2	F3 ²¹	F4 ²¹
EB 2000 kg	+33 -1,5	+28 -4,0	±13,4	±10,5
EB 2600 kg	+35 -1,6	+29 -4,4	±13,7	±10,6

Upper platform with stone layer ¹⁸

usable platform width	F1	F2	F3 ²¹	F4 ²¹
EB 2000 kg	+46 -2,1	+39 -5,7	±15,5	±11,0
EB 2600 kg	+48 -2,2	+40 -6,1	±15,9	±11,1

Platform load in lbs

Upper platform with sheet metal plates ¹⁹

usable platform width	F1	F2	F3 ²¹	F4 ²¹
EB 4400 lbs	+7,419 -337	+6,295 -899	±3,012	±2,360
EB 5730 lbs	+7,868 -360	+6,519 -989	±3,080	±2,383

Upper platform with stone layer ¹⁹

usable platform width	F1	F2	F3 ²¹	F4 ²¹
EB 4400 lbs	+10,341 -472	+8,768 -1,281	±3,485	±2,473
EB 5730 lbs	+48 -10,791	+8,992 -1,371	±3,574	±2,495

! Units are dowelled to the floor. Drilling depth: approx. 15 cm [6"].
Floor and walls below the drive-in level are to be made of concrete (quality minimum C20/25)!

¹⁶ Dimension B see page 2

¹⁷ Marking compliant to ISO 3864 (colors used in this illustration are not ISO 3864 compliant)

¹⁸ All forces in kN

¹⁹ All forces in lbf

²⁰ The loading capacity of the base plate must be proved by a structural engineer. Possibly stronger base plate could be necessary.

²¹ In the case of wind-protected installation, the forces F3 and F4 are reduced by 9 kN [2,023 lbf].

- Page 1
Section
Dimensions
Car data
- Page 2
Width
dimensions
- Page 3
Width
dimensions
- Page 4
Function
Approach
Load per
parking sp.
- Page 5
Load plan
- Page 6
Pit edge
- Page 7
Electrical
installation
Technical
data
- Page 8
Tec. data
To be performed by the customer
- Page 9
Description

Pit edge / Drainage

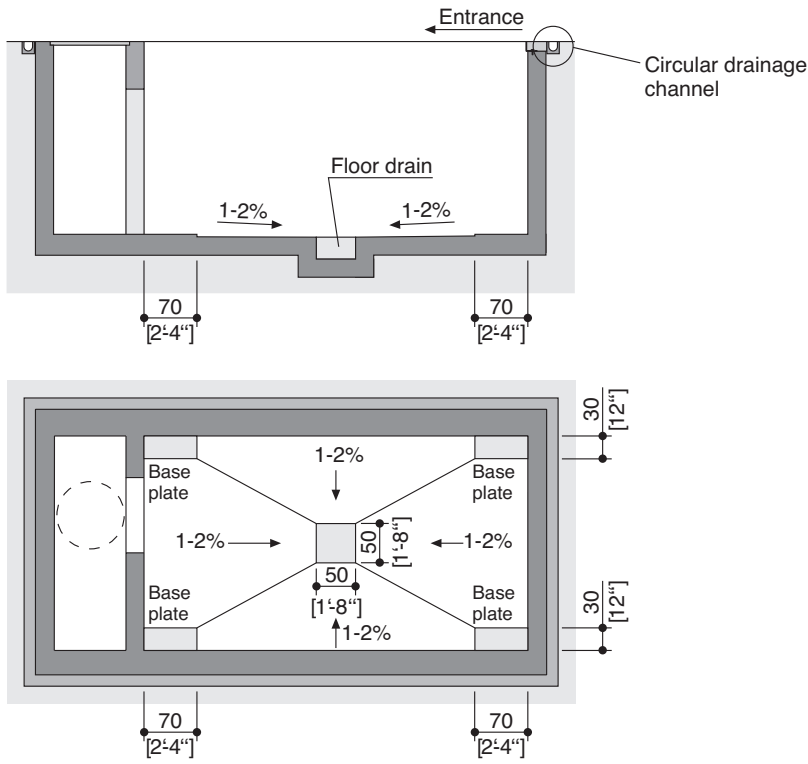

Pit edge / On-site coating of the uppermost platform

Maximum weight of customer coating 250 kg/m² [5933 lbs/ft²].

Coating with asphalt or concrete

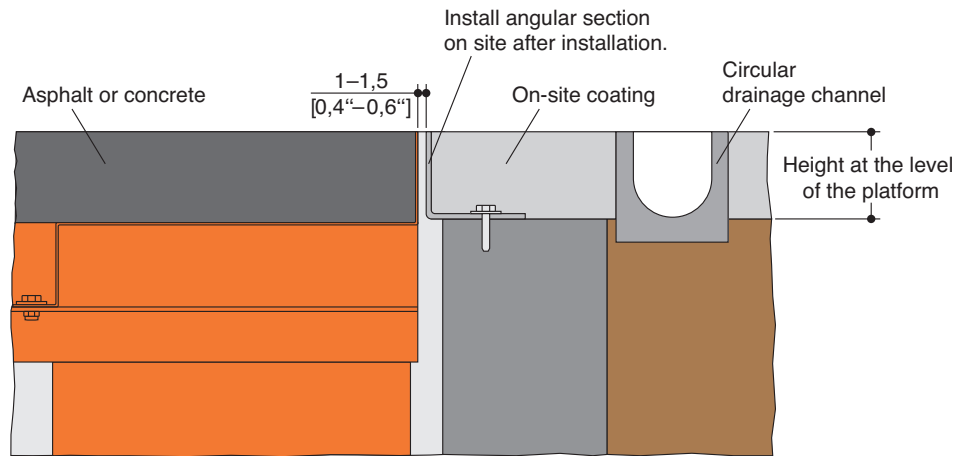

Coating with paving stones

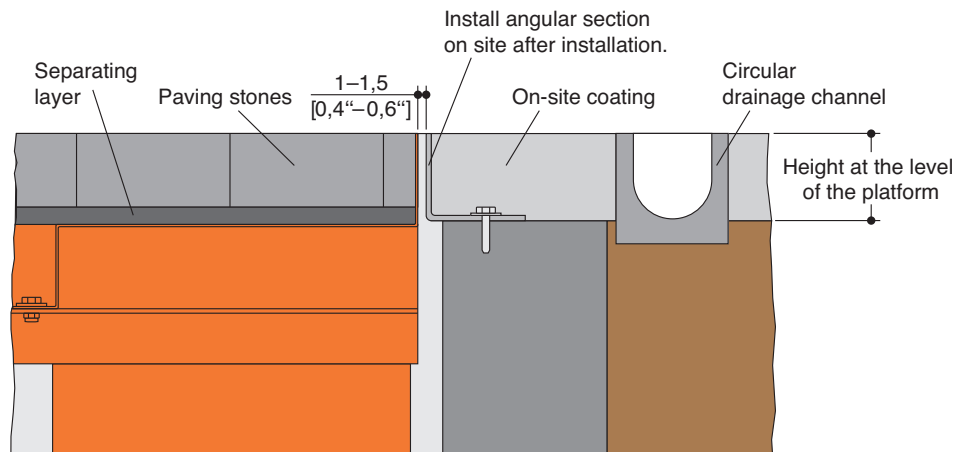

Page 1
Section
Dimensions
Car data

Page 2
Width
dimensions

Page 3
Width
dimensions

Page 4
Function
Approach
Load per
parking sp.

Page 5
Load plan

Page 6
Pit edge

Page 7
Electrical
installation
Technical
data

Page 8
Tec. data
To be performed by
the customer

Page 9
Description

Electrical installation

Installation diagram

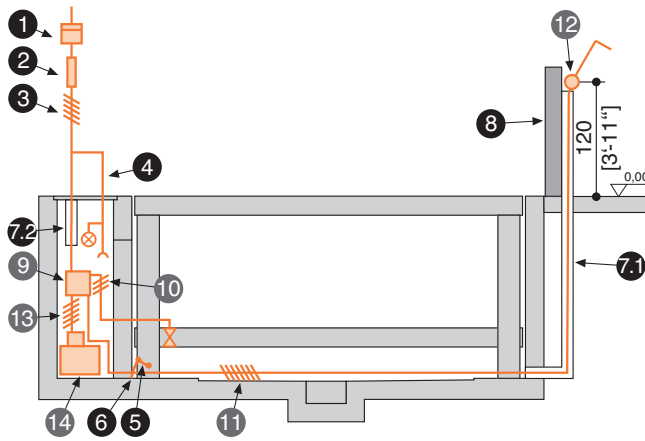

Electrical data (to be performed by the customer)

No.	Quantity	Description	Position	Frequency
1	1	Electricity meter	in the supply line	
2	1	Main fuse: 3 x fuse 20 A (slow) or circuit breaker 3 x 20 A (trigger characteristic K or C)	in the supply line	1 per 5.2 kW unit
		2 x fuse 35 A (slow) or circuit breaker 3 x 35 A (trigger characteristic K or C)	in the supply line	1 per 3.7 kW unit
		3 x fuse 25 A (slow) or circuit breaker 3 x 25 A (trigger characteristic K or C)	in the supply line	1 per 4.0 kW unit
3	1	Supply line 5 x 2.5 mm ² (3 PH + N + PE) with marked wire and protective conductor	to main switch	1 per 5.2 kW unit
		Supply line 3 x AWG 10 (2 PH + PE) with marked wire and protective conductor	to main switch	1 per 3.7 kW unit
		Supply line 4 x AWG 12 (3 PH + PE) with marked wire and protective conductor	to main switch	1 per 4.0 kW unit
4	1	Separate supply line (230 V) with lighting and power outlet	from supply line into the shaft	1 per system
		Separate supply line (120 V) with lighting and power outlet	from supply line into the shaft	1 per system
5	every 10 m	Foundation earth connector	corner pit floor	
6	1	Equipotential bonding in accordance with DIN EN 60204 from foundation earth connector to the system		1 per system
7.1	1	Empty pipe DN 40 with taut wire	base pit to operating device	1 per system
7.2	1	Empty pipe DN 40 with taut wire	supply line to hydraulic unit	1 per system
8	1	Stand for operating device		1 per system

Electrical data (included in delivery of KLAUS Multiparking)

No.	Description
9	Control box with lockable main switch
10	Control line 3 x 0.75 mm ² (PH + N + PE)
11	Control line 7 x 1 mm ² with marked wire and protective conductor
12	Operating device
13	Control line 4 x 2.5 mm ² with marked wire and protective conductor
14	Hydraulic unit 5.2 kW with three-phase current, 230/400 V - 50 Hz Hydraulic unit 3.7 kW with two-phase current, 240 V - 60 Hz Hydraulic unit 4.0 kW with three-phase current, 120/208 V - 60 Hz

Technical data

Field of application

By default, the system can only be used for a fixed number of users. If required, would you please contact us.

Units

Low-noise power units mounted to rubber-bonded-to metal mountings are installed. Nevertheless we recommend that parking system's garage be built separately from the dwelling.

Available documents

- maintenance offer/contract
- declaration of conformity

Building application documents

According to LBO and GaVo (garage regulations) the Multiparking systems are subject to approval. For the building application please submit this data sheet.

Corrosion protection

See separate sheet regarding corrosion protection.

Care

To avoid damages resulting from corrosion, make sure to follow our cleaning and care instructions and to provide good ventilation of your garage.

Safety grids

If the permissible drop opening is exceeded, safety grids are to be mounted on the systems. If there are traffic routes next to or behind the installations, barriers compliant to DIN EN ISO 13857 must be installed by the customer. Barriers must also be in place during construction.

Environmental conditions

Environmental conditions for the area of multiparking systems: Temperature range -20 to +40° C [-4 to +104° F].

Relative humidity 50% at a maximum outside temperature of +40° C [+104° F].

If lifting or lowering times are specified, they refer to an environmental temperature of +10° C [+50° F] and with the system set up directly next to the hydraulic unit. At lower temperatures or with longer hydraulic lines, these times increase.

CE Certification

The systems offered correspond to DIN EN 14010 and the EC Machinery Directive 2006/42/EG.

Page 1
Section
Dimensions
Car data

Page 2
Width
dimensions

Page 3
Width
dimensions

Page 4
Function
Approach
Load per
parking sp.

Page 5
Load plan

Page 6
Pit edge

Page 7
Electrical
installation
Technical
data

Page 8
Tec. data
To be performed by the customer

Page 9
Description

Technical data

Sound insulation

As per DIN 4109-1 (sound insulation in building construction), Section 9, KLAUS Multiparker are in the range of technical domestic installations (garage systems).

Normal sound insulation:

DIN 4109-1, Section 9, maximum permissible A-rated sound levels in rooms requiring external protection, generated by technical domestic installations and commercial businesses affiliated with the building.

Table 9 shows the values for the maximum permissible A-rated sound levels in rooms requiring external protection, generated by technical domestic installations and business affiliated with the building. As per line 2, the maximum sound level in living rooms and bedrooms must not exceed 30 dB (A). *User noises are not subject to the requirements (DIN 4109-1, Section 9).*

The following measures are required to comply with this value:

- Sound protection package according to offer/order (KLAUS Multiparking GmbH)
- Minimum sound insulation of the building of min. $R'_w = 57$ dB (service/item to be provided by the customer)

Increased sound insulation (special agreement):

VDI 4100 (sound insulation in building construction) Assessment and proposals for enhanced sound insulation.

Agreement: Maximum sound level in living rooms and bedrooms 25 dB (A). *User noises are not subject to the requirements (see VDI 4100, Paragraph 1, Scope of application – Notes).*

The following measures are required to comply with this value:

- Sound protection package according to offer/order (KLAUS Multiparking GmbH)
- Minimum sound insulation of the building of min. $R'_w = 62$ dB (service/item to be provided by the customer)

Note: User noises are basically noises that can be individually influenced by the user of our Multiparking systems. These include, for example, driving on the platform, slamming vehicle doors, engine and brake noises.

To be performed by the customer

Safety fences

Any constraints that may be necessary according to DIN EN ISO 13857 in order to provide protection for the park pits for pathways directly in front, next to or behind the unit. This is also valid during construction. Safety grids on the systems are, if necessary, optionally available against surcharge.

Numbering of parking spaces

Consecutive numbering of parking spaces.

Building services

Any required lighting, ventilation, fire extinguishing and fire alarm systems as well as clarification and compliance with the relevant regulatory requirements.

Drainage

In the middle of the pit a floor drain with connection to the cable network or a pump sump is to be provided. The water is to be drained with a pump to be provided by the customer. From the pit corners/bearing surface of the lifting columns an incline to the floor drain/pump sump is necessary.

For reasons of environmental protection we recommend to paint the pit floor, and to provide oil and petrol separators in the connections to the public sewage network.

To divert large amounts of water from the court area, we recommend that the customer install a water drainage channel around the periphery of the pit.

Marking

In compliance with DIN EN 14010, 10 cm [4"] wide yellow-black markings compliant to ISO 3864 must be applied by the customer to the edge of the pit in the entry area to mark the danger zone.

Wall cuttings

Any necessary wall cuttings according to page 2.

Operating device

The customer must provide a cable duct (Helfamin-tube) from pit floor to operating device. The location of the control element must be specified according to the project (control stand, house wall, etc.).

Installing vertical columns

In general, a crane must be supplied by the customer for installation of the telescope columns.

Hook clearance min. 400 cm [13'-1"] over access level, crane load approx. 700 kg [1543 lbs].

Electrical supply to the main switch / Foundation earth connector

Suitable electrical supply to the main switch must be provided by the customer during installation. The functionality can be monitored on site by our fitters together with the electrician. If this cannot be done during installation for some reason for which the customer is responsible, the customer must commission an electrician at their own expense and risk.

In accordance with DIN EN 60204 (Safety of Machinery. Electrical Equipment), grounding of the steel structure is necessary, provided by the customer (distance between grounding max. 10 m [32'-10']).

Maintenance manhole

A separate maintenance manhole with manhole cover, ladder and a connecting passage to the pit must be installed by the customer. In multiple systems, a shared maintenance manhole may be sufficient, depending on the project.

Lighting

The customer must comply with DIN 67528 »Artificial lighting of parking areas and parking houses« for the parking structure lighting. The intensity of illumination in the pit and in the maintenance manhole must be min. 80 Lux.

Ventilation

To achieve a constant exchange of air, reduce humidity, prevent condensation, and reduce vehicle moisture (due to rain, snow, ice, etc.), it is recommended that the customer consult specialized engineers for heating, ventilation, and climate control and install a ventilation system. This will reduce or prevent the hazard of corrosion and its attendant failures.

If the following are not included in the quotation, they will also have to be provided / paid for by the customer:

- Mounting of contactor and terminal box to the wall valve, complete wiring of all elements in accordance with the circuit diagram
- Costs for final technical approval by an authorized body
- Main switch
- Control line from main switch to hydraulic unit

Coating on the uppermost platform

On-site coating of the uppermost platform according to sectional drawing on page 2 (maximum weight of customer coating 250 kg/m² [5933 lbs/ft²]).

Page 1
Section
Dimensions
Car data

Page 2
Width
dimensions

Page 3
Width
dimensions

Page 4
Function
Approach
Load per
parking sp.

Page 5
Load plan

Page 6
Pit edge

Page 7
Electrical
installation
Technical
data

Page 8
Tec. data
To be performed by the
customer

Page 9
Description

Description Single platform (EB)

General description:

Multiparking system providing independent parking spaces for 1 car (EB). On special conditions the upper platform may be used as parking space.

Dimensions are in accordance with the underlying dimensions of parking pit, height and width.

The parking bays are accessed horizontally (installation deviation $\pm 1\%$).

Vehicles are positioned on each parking space using wheel stops on the right side (adjust according to operating instructions).

Operation via operating device with key interlock using master keys.

Operating instructions are attached to each operator's stand.

Multiparking system consisting of:

- 2 telescopic lifting columns at rear with hydraulic cylinder (mounted to the floor)
- 2 telescopic lifting columns at front (mounted to the floor)
- 1 upper platform (for floor coating to be provided by the customer, e.g. sand layer/stone layer, please KLAUS Multiparking). Maximum weight of customer coating 250 kg/m^2 [5933 lbs/ft²]. Optional design with platform sheet metal plates from KLAUS Multiparking, against surcharge.
- 2 lower platforms
- 1 mechanic synchronization control system (to ensure synchronous operation of the hydraulic cylinders while lowering and lifting the platform)
- 2 hydraulic cylinders
- Dowels, screws, connecting elements, bolts, etc.
- The platforms and parking spaces are end-to-end accessible for parking!

Upper platform consisting of:

- Covering plates
- Side members
- Cross members
- Tray for customer coating, optional platform sheet metal plates from KLAUS Multiparking
- Screws, nuts

Lower platforms consisting of:

- Platform base sections
- Adjustable wheel stops
- Canted access plates
- Side members
- Cross members
- Screws, nuts, washers, distance tubes, etc.

Hydraulic system consisting of:

- Hydraulic cylinder
- Magnetic valve
- Hydraulic conduits
- Screwed joints
- High-pressure hoses
- Installation material

Electric system consisting of:

- Operating device (Emergency Stop, lock, 1 master key per parking space)
- Control box with lockable main switch

Hydraulic unit consisting of:

- Hydraulic power unit (low-noise, installed onto a console with a rubber-bonded-to-metal mounting)
- Hydraulic oil reservoir
- Oil filling
- Internal geared wheel pump
- Pump holder
- Clutch
- AC-motor
- Contactor (with thermal overcurrent relay and control fuse)
- Test manometer
- Pressure relief valve
- Hydraulic hoses (which reduce noise transmission onto the hydraulic pipe)

We reserve the right to change this specification without further notice

KLAUS Multiparking reserves the right in the course of technical progress to use newer or other technologies, systems, processes, procedures or standards in the fulfillment of their obligations other than those originally offered provided the customer derives no disadvantage from their so doing.